

Duo Wall Sconce

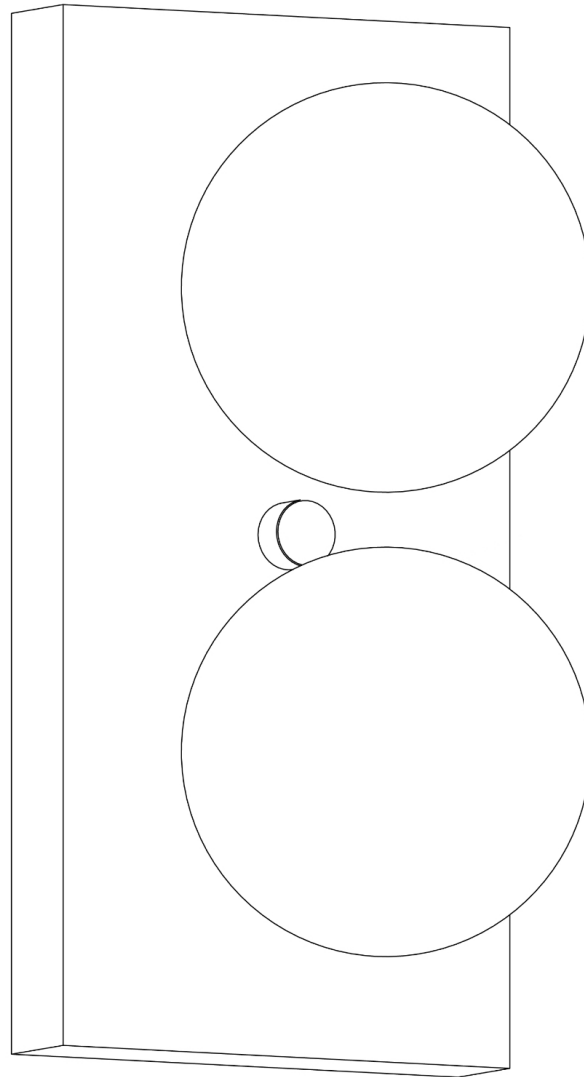

LED Lamping Style G9
NOT INCLUDED



Contents

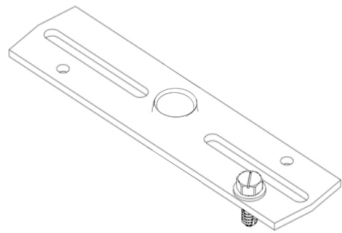

— crossbar

2x glass shades —

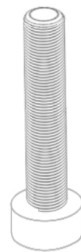
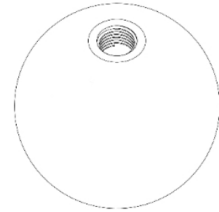

— bottom cap with nipple

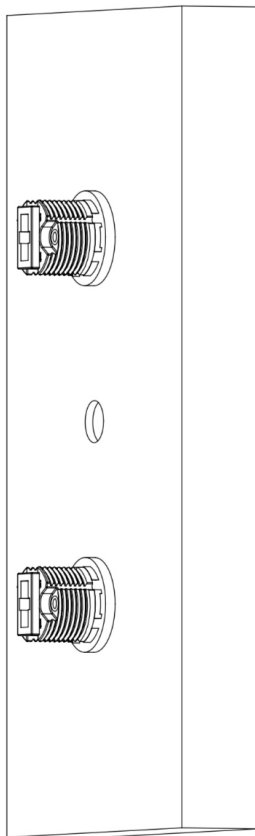

— duo

3x wire nuts —



4x #8-32 screws —

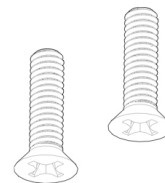

1. Mount the crossbar to the junction box using the provided #8-32 screws.

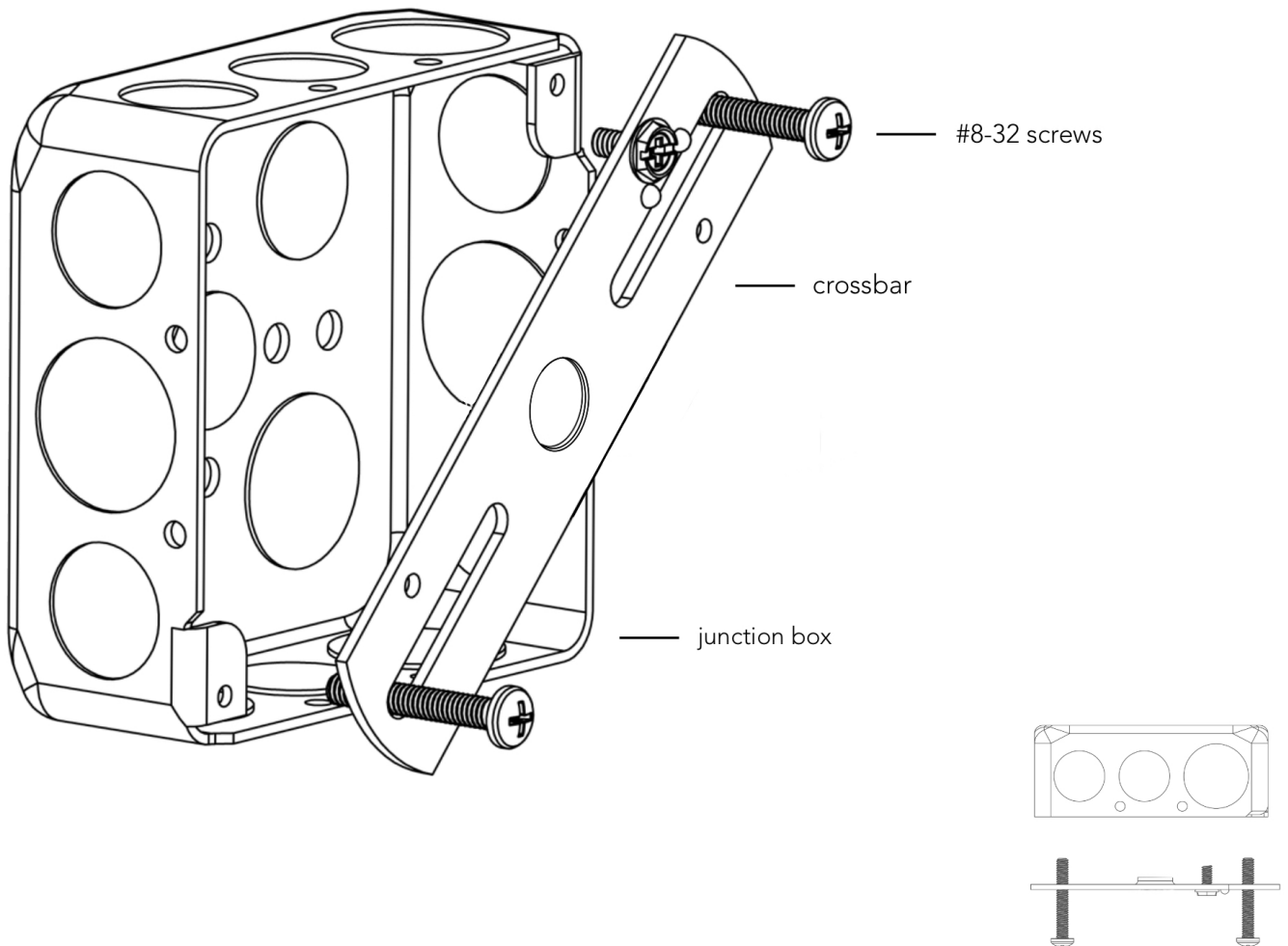

2. Hold the fixture backplate close to the wall and connect the fixture ground wire to the wall ground wire.
3. Connect the +/- fixture wires to the +/- wall wires.

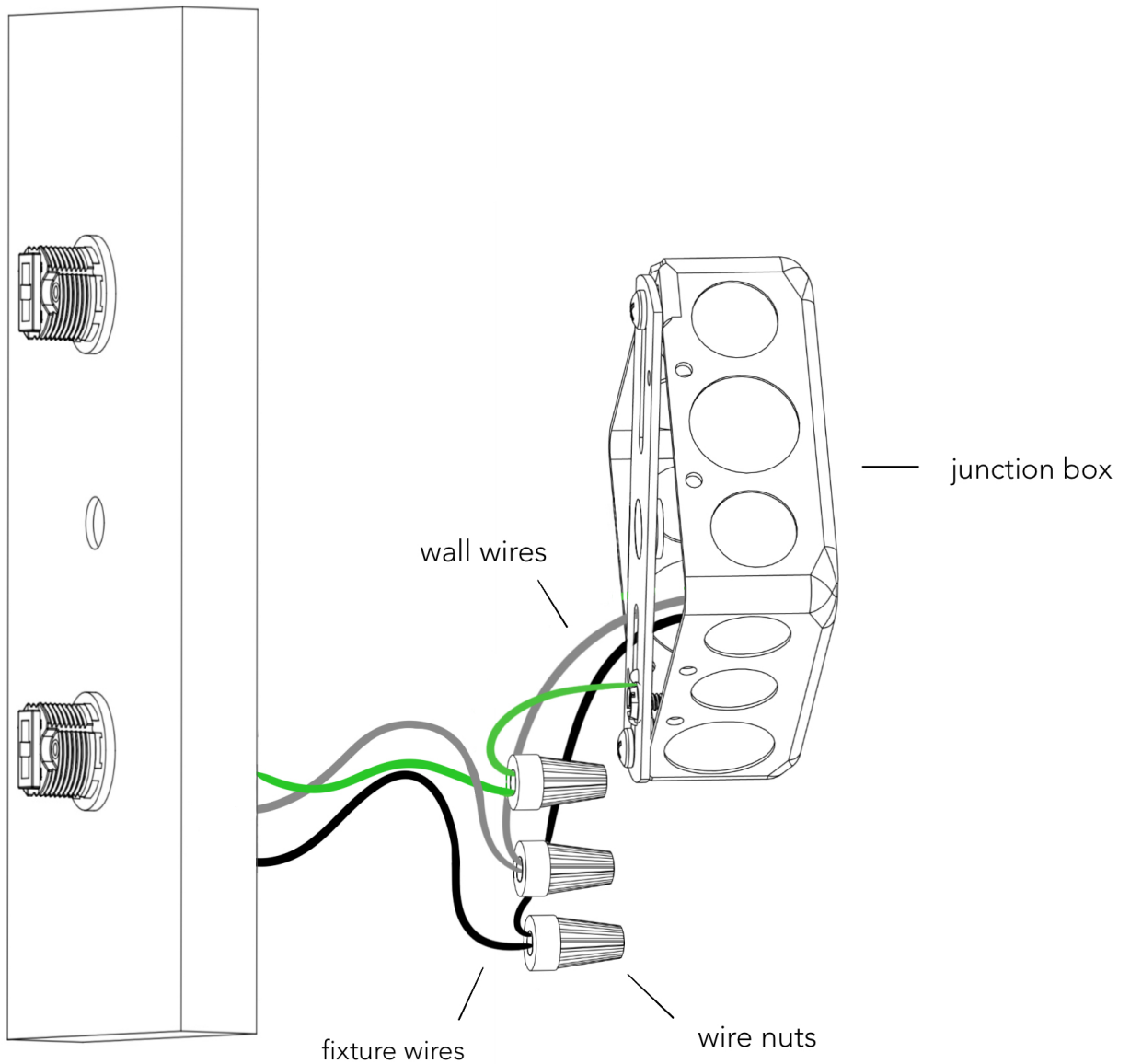

4. Feed the cap with the nipple through the canopy and twist so the nipple threads through the crossbar.
5. Twist the cap until it is flush with the duo body.

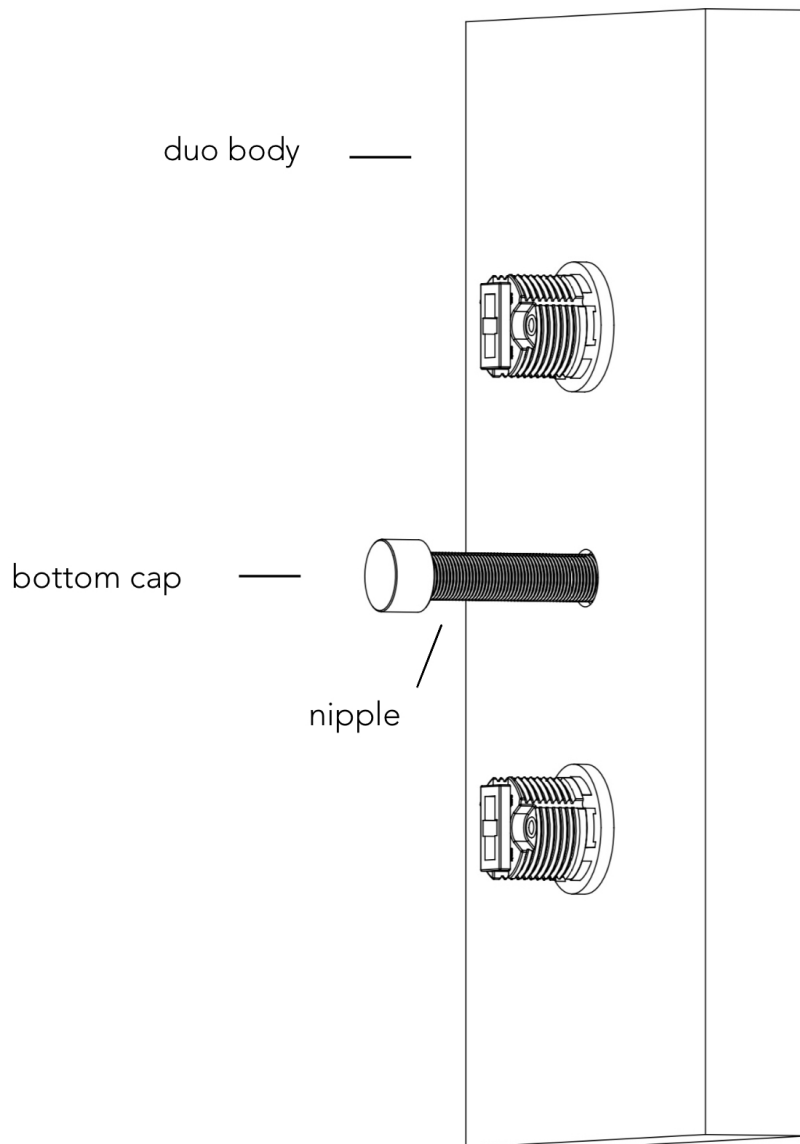

6. Insert G9 bi pin LED bulbs into the sockets and then install the glass shades by threading them onto the G9 threaded sockets. See detail in bottom right.

